

Technical Specifications (FSD LS)	MiTR 3700 mm WB (7 m)	MiTR 4270 mm WB (8 m)	
Seating			
Seating Capacity	2 x 2	23+D High Back Seats 27+D – Standard Seats	27 + D - High Back Seats 31+D Single Door - Standard Seats
	2 x 1	25 + D - Double Door - Standard Seats 19+D (Push Back)	29+D - Double Door - Standard Seats 22+D (Push Back)
Powertrain			
Engine Type	ZD30 DDTI CRD Engine BS VI		
Displacement	2953 cc		
Maximum Power Output (KW @rpm)	104.3 KW @ 2750 rpm		
Maximum Torque (Nm)	360 Nm @ 1350 – 2750 rpm		
Clutch	310 mm diameter Single dry plate, Diaphragm- Push type, Hydraulic actuated		
Transmission	Fully synchronized 5 speed Manual Gearbox		
Fuel System			
Fuel Tank Capacity (in litre)	90L		
Brakes			
Service Brakes	Vacuum assisted Hydraulic brake		
Parking Brakes	Transmission mounted		
Suspension & Tyres			
Front & Rear Suspension	Parabolic, Overslung suspension with Double acting Shock Absorbers		
No. of Tyres	Front 2, Rear 4, Spare - 1		
Tyre Size	7.00 x 16, 14 PR	7.5 x 16, 16 PR	
Weight			
Gross Vehicle Weight (kg)	6650kg	7200kg	
Dimensions			
Wheel Base (mm)	3700	4270	
Overall Dimensions (mm)	7060 X 2200 X 2630 (Non AC), 7060 x 2200 X 2850 (AC)	7970 X 2200 X 2630 (Non AC), 7970 X 2200 X 2850 (AC)	
Passenger Platform Height (mm)	786	1000	
Min. Turning Radius (m)	7.2	8.3	
AC Specifications			
Compressor	220 cc, 20 Kw	220 cc + 160 cc, 25 Kw	
Cooling Unit	Roof Mounted	Roof Mounted	
Window Glass	Tinted (30%)	Tinted (30%)	
Electricals			
Electrical Description	Single Pole 12V		
Battery in Ah (Non AC/AC)	75/110		
Alternator (A) (Non AC/AC)	90/140		

FEATURES	MiTR 3700 WB (7 m)	MiTR 4270 WB (8 m)
Comfort & Convenience		
Tilttable Power Steering	✓	✓
Reclining and Sliding Driver Seat	✓	✓
Grab Rail on the Passenger Door	✓	✓
Modern Dual Tone Dashboard	✓	✓
Dual Tone Vinyl Seats	✓	✓
Interiors		
Digital Odometer	✓	✓
Trip Odometer	✓	✓
Flooring - Vinyl Button Type	✓	✓
Roof Panel - Pre-painted GI Sheet	✓	✓
Lockable Glove Box	✓	✓
Safety		
Low Vacuum in Brake Booster Indicator	✓	✓
Steering Lock with Single Key for Door and Fuel Tank Lid	✓	✓
Safety Light in Door Footwell Area	✓	✓
Passenger Door - Jack & Knife (Opens inwards)	✓	✓
Fire Extinguisher	✓	✓
Partition behind Driver Seat	✓	✓

SEATING CONFIGURATIONS

3700 - WB

19 + D (Push Back) in 2 x 1 layout

23+D (2x2) High-back Seat – Non-Reclining

27+D (2x2) Standard Seats
25+D (2x2) – Double Door – Standard Seats

4270 - WB

22+D (Push Back) in 2 x 1 layout

31+D (2x2) Standard Seats
27+D (High Back Seats)

29+D (2X2) Double Door – Standard Seats

PASSENGER SALOON

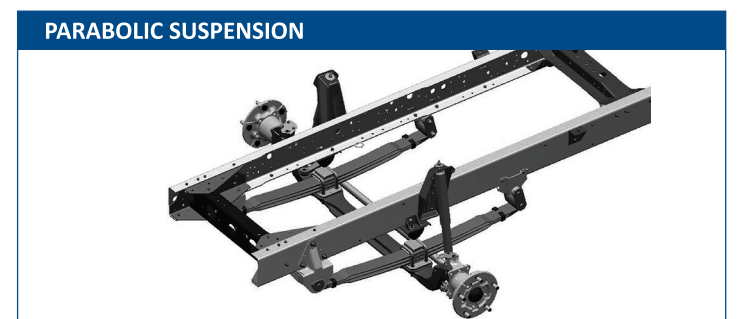

- ADDED BENEFITS**
- Service at Site Van for 24 x 7 Emergency Assistance
 - 575+ Touch Points Pan India
 - Attractive and Hassle Free Annual Maintenance Packages available

For further details, please contact: 1800 1022 666 (toll-free) Web: www.ashokleyland.com
Or write to us at: Ashok Leyland Limited, 6th Floor - LCV Marketing, No.1 Sardar Patel Road, Guindy, Chennai - 600 032. Tel: (044) 22206000

Authorised dealer:

Terms and conditions apply.
Disclaimer: Under standard test conditions. Accessories shown are not a part of the standard equipment. The illustrations, colours shown are indicative only and the actual may vary. Ashok Leyland reserves the right to change specifications/designs without prior permission and notice, without any liability in view of our policy of continuous improvement. December 2022. WB = Wheel Base. Decals shown are for representative purpose only. The Standard Warranty (Vehicle & Rear Axle) is 2 years unlimited km & the warranty on Driveline (Engine & Gearbox) is 3 years or 300 000 km whichever is earlier.



COMING TO WORK WON'T BE HARD WORK ANYMORE
Presenting BS6 MiTR STAFF BUS with **i-Gen6** Technology.



MiTR
STAFF BUS

10%*
More Fuel Efficiency



1 Zyaada TECHNOLOGY

ADVANCED Selective Catalytic Reduction (SCR) Technology - Better Reduction of NOx, CO, HC & PM

Greener and Cleaner Technology



Globally Proven Japanese Engine

i-Gen6 TECHNOLOGY

INNOVATIVE | INTELLIGENT | INDIAN

6 ka DUM

ZYAADA se ZYAADA PROFIT

MiTR

STAFF BUS

MORE ON VALUE | LESS ON YOUR POCKET

2 Zyaada MILEAGE

Get MORE Mileage with Superior and Proven ZD30 Engine. Highly efficient Bosch 2.2 CRi Common Rail System with Advance Direct Injection

10% More Mileage

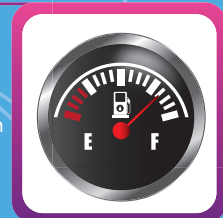

4 Zyaada SAFETY

- AIS 153 & AIS 052 Bus Body Code Certified
- Vehicle Tracking System (VTS)*
- Fire Detection and Alarm System (FDAS)

Superior Safety



5 Zyaada COMFORT

- Designed for Indian Roads
- Ergonomically Designed Passenger Seats
- Ergonomically Designed Driver Cabin
- Tilttable Power Steering for Fatigue Free Driving

Factory Fitted AC and Power Steering



6 Zyaada BHAROSA

- Engine & Transmission warranty of 3 years / 300 000 km which ensures customers can be Tension Free
- High Reliability and Proven Performance.

3 years or 300 000 km*

Zyaada Safety Design



Sturdy Body Cage Design With Structural Reinforcements Ensure 100% Safety

100%* Rollover Compliant

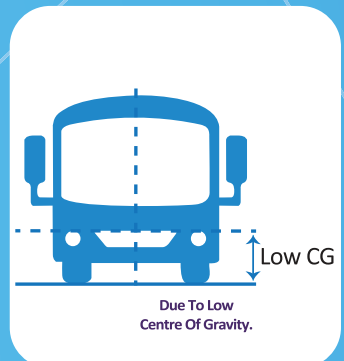

Due To Low Centre Of Gravity.

Improved Stability

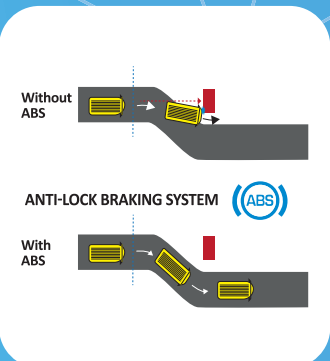

Without ABS
ANTI-LOCK BRAKING SYSTEM (ABS)
With ABS

ABS



Grab Handles



Anti Skid Flooring

Zyaada Ride Comfort & Low NVH

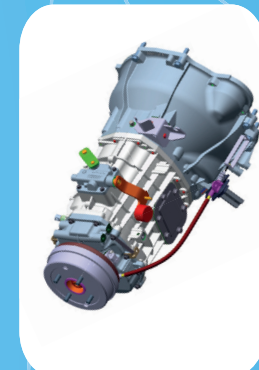

5 Speed Overdrive Synchro Gear Box

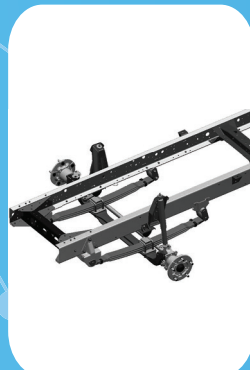

First in Class Parabolic Suspension



Modern Ergonomic Passenger Saloon



Integrated AC Louvers



Ergonomic Driver Saloon

Zyaada Peace Of Mind

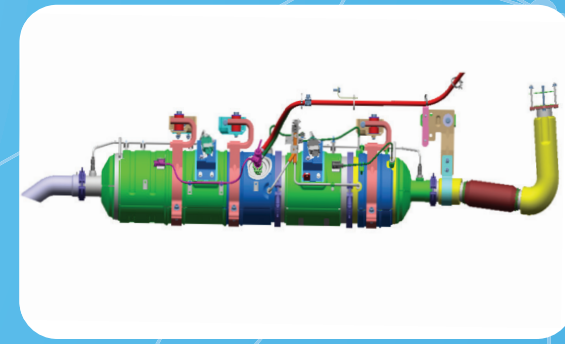

Advanced SCR Technology



Modern Digital Cluster



Fire Detection & Alarm System*



Vehicle Tracking System*



First Aid Kit & Fire Extinguisher